



KB article reference no. Q101103

Version: 1.1

Keywords: KlasHopper 600 PCMCIA, KIV-7

Dial with a KlasHopper 600 connected to a KIV-7

The information in this article applies to:

- Windows 2000 Professional
- KlasHopper 600 PCMCIA
- Dial-up Networking
- KIV-7

Table of Contents

1.0 Introduction.....	2
2.0 Cable Connections	2
3.0 Configure the OMNIxi.....	2
4.0 KlasHopper 600 PCMCIA Setup (Dial):	3
5.0 Dial-up Connection Configuration	4
6.0 Call Setup.....	8

Table of Figures

Figure 1. Sample Scenario using the KlasHopper 600 PCMCIA	2
Figure 2. KlasHopper 600 PCMCIA Setup Screen	3
Figure 3. Opening the Network and Dial-up Connections Window.....	4
Figure 4. Starting the Network Connection Wizard	4
Figure 5. Choosing the Network Connection Type	5
Figure 6. Selecting the Network Device	5
Figure 7. Entering the Mandatory Dial-Up Number.....	6
Figure 8. Selecting the Connection Availability.....	6
Figure 9. Naming the Dial-Up Connection.....	7
Figure 10. Editing the Dial-Up Connection Properties.....	7
Figure 11. Configuring the Dial-Up Connection for TCP/IP	8
Figure 12. Initiating the KlasHopper PPP Connection	8

1.0 Introduction

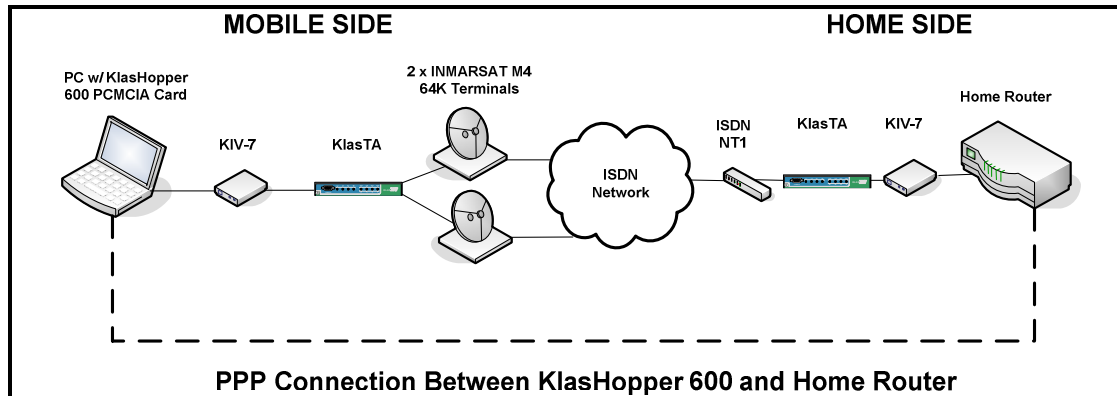

Figure 1. Sample Scenario using the KlasHopper 600 PCMCIA

This document describes how to configure the KlasHopper 600 PCMCIA to dial with a KIV-7. Figure 1 represents a typical KlasHopper scenario in a deployed environment using satellite communications to connect back to a home network. In this example, the KlasHopper 600 on the Mobile Side is initiating a PPP connection using the KIV-7 for Type-1 Encryption. On the Home Side, the PPP connection can be terminated by either a router or another PC. On both sides, a KlasTA is used to access the Public ISDN network through the M4 INMARSAT terminals. Follow the directions in this document to configure the KlasHopper 600 network interface and complete the steps required to create and use a Dial-up Networking connection from a Windows 2000 PC.

2.0 Cable Connections

Prior to beginning, ensure the following cable connections have been properly secured:

1. KlasHopper 600 cable (KHHS026) is connected to the female RS-530 connector on the KIV-7.
2. Black KIV-7 cable is connected to the male RS-530 connector of the KIV-7 and the female RS-530 synchronous serial port on the KlasTA.
3. ISDN cables are connected to the RJ-45 ISDN Output Ports 1 and 2 from KlasTA and the ISDN ports on each M4 Terminal.

3.0 Configure the KIV-7

The KIV-7 has a specific sequence of settings that allow it to encrypt data using the RS-530 serial data port. Follow the instructions from Application Note Q100004 in order to configure the KIV-7 so that it will work properly with the KlasHopper 600 and KlasTA.

4.0 KlasHopper 600 PCMCIA Setup (Dial):

To configure the KlasHopper 600 PCMCIA network interface, follow the instructions below.

1. From the Windows 2000 Desktop, go to Start – Programs – KlasHopper 600 PCMCIA – KlasHopper 600 PCMCIA Configure.
2. In the KlasHopper 600 PCMCIA Setup Screen, select the 'Manual Dial' option from the 'Connection Mode' field.
3. Select 'RS-530/RS-449/X.21' option from the 'Interface' field.
4. No other settings are required. Click the 'OK' button to continue.

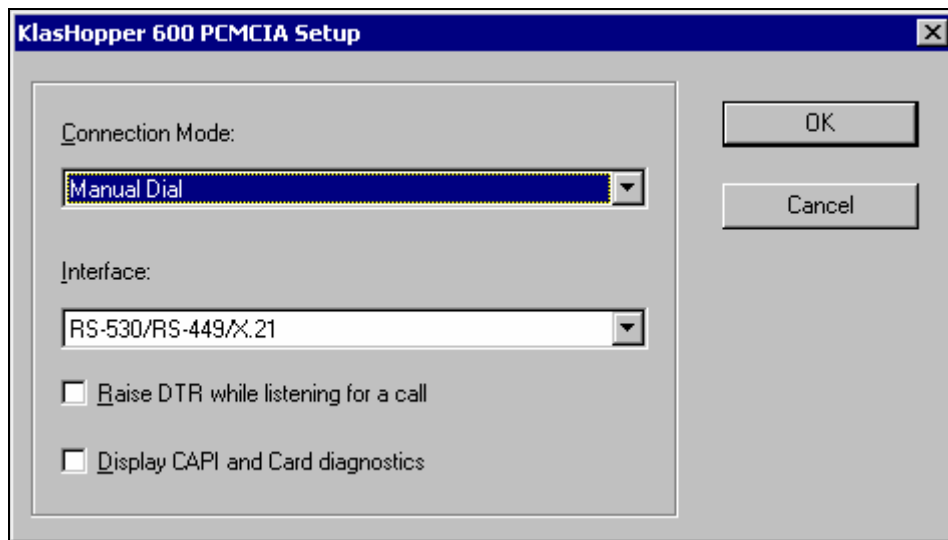

Figure 2. KlasHopper 600 PCMCIA Setup Screen

5.0 Dial-up Connection Configuration

To create a Dial-up Networking connection, follow the directions below.

1. Go to Start – Settings – Network and Dial-up Connections, as shown in Figure 3 below.

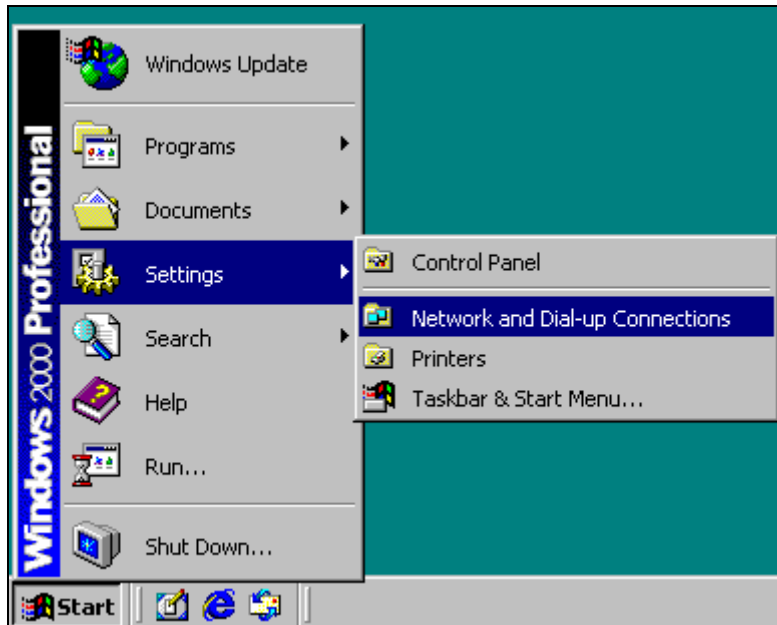

Figure 3. Opening the Network and Dial-up Connections Window

2. Double-click on the 'Make New Connection' icon to start the Network Connection Wizard. Click 'Next' to continue past the Welcome screen.



Figure 4. Starting the Network Connection Wizard

Dial with a KlasHopper 600 Connected to a KIV-7

3. Select the 'Dial-up to private network' option. Click 'Next' to continue.

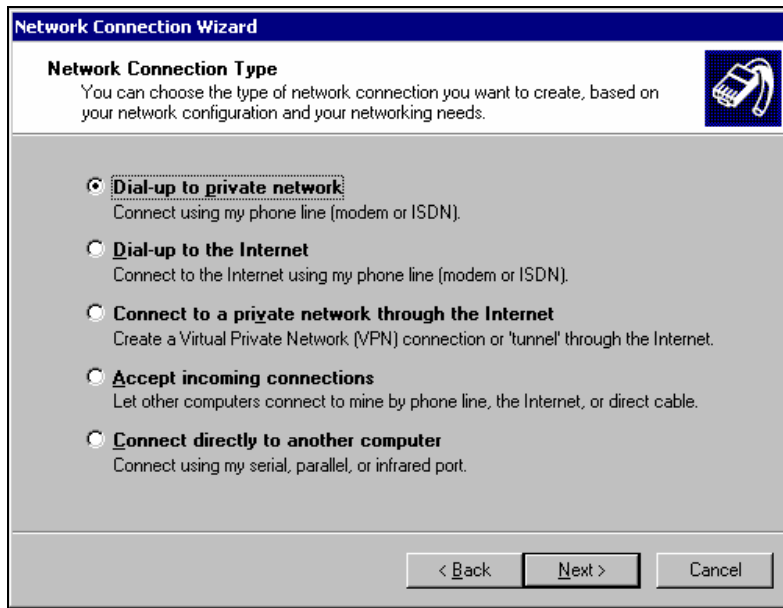

Figure 5. Choosing the Network Connection Type

4. Ensure that 'Modem – KlasHopper 600 PCMCIA PPP' is the only device that is selected. Click 'Next' to continue.



Figure 6. Selecting the Network Device

5. Enter a number in the 'Phone number' field. e.g. 123 (Windows requires a number to be present; however, this number will not be used). Click 'Next' to continue.

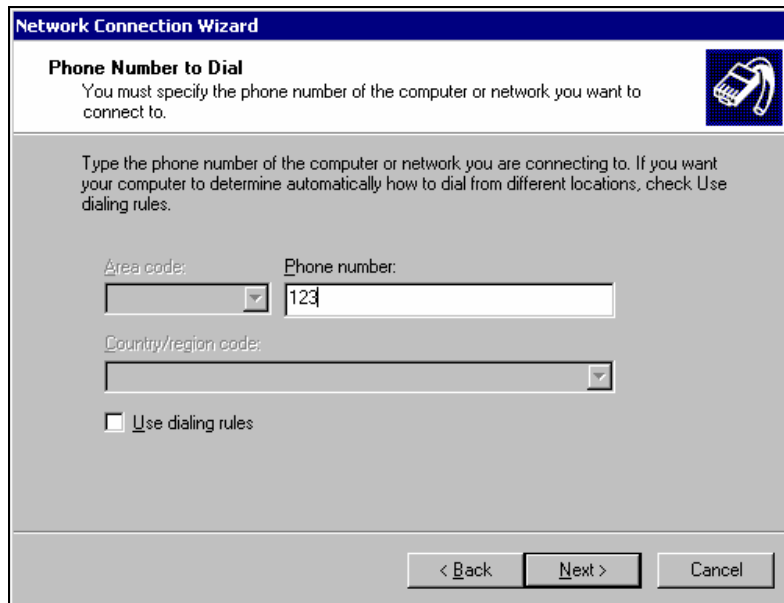

The screenshot shows the 'Network Connection Wizard' window. The title bar reads 'Network Connection Wizard'. The main heading is 'Phone Number to Dial'. Below the heading, there is a sub-heading 'Phone Number to Dial' and a paragraph: 'You must specify the phone number of the computer or network you want to connect to.' To the right of this text is a small icon of a telephone handset. Below this, there is another paragraph: 'Type the phone number of the computer or network you are connecting to. If you want your computer to determine automatically how to dial from different locations, check Use dialing rules.' There are three input fields: 'Area code:' with a dropdown arrow, 'Phone number:' with a text box containing '123', and 'Country/region code:' with a dropdown arrow. Below these fields is a checkbox labeled 'Use dialing rules'. At the bottom of the window are three buttons: '< Back', 'Next >', and 'Cancel'.

Figure 7. Entering the Mandatory Dial-Up Number

6. Select the Connection Availability that suits you. Click 'Next' to continue.



The screenshot shows the 'Network Connection Wizard' window. The title bar reads 'Network Connection Wizard'. The main heading is 'Connection Availability'. Below the heading, there is a sub-heading 'Connection Availability' and a paragraph: 'You may make the new connection available to all users, or just yourself.' To the right of this text is a small icon of a telephone handset. Below this, there is another paragraph: 'You may make this connection available to all users, or keep it only for your own use. A connection stored in your profile will not be available unless you are logged on.' There is a section titled 'Create this connection:' with two radio button options: 'For all users' (which is selected) and 'Only for myself'. At the bottom of the window are three buttons: '< Back', 'Next >', and 'Cancel'.

Figure 8. Selecting the Connection Availability

7. Enter a relevant name for the connection. Click 'Finish' to complete the wizard.

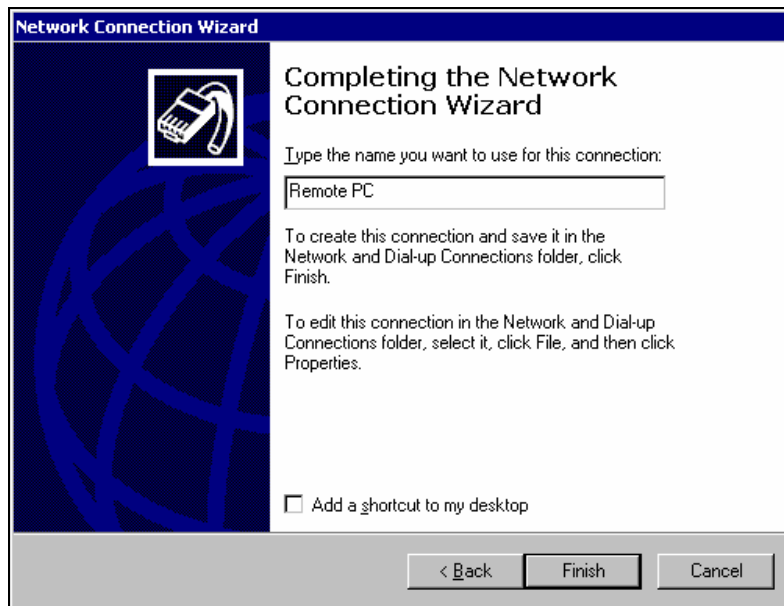

Figure 9. Naming the Dial-Up Connection

8. Once the connection has been created, right-click on the icon and select 'Properties'.

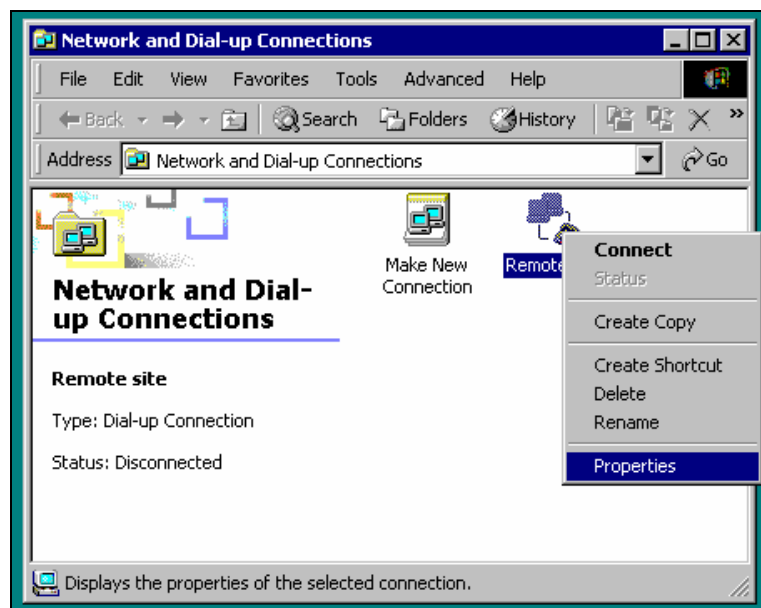

Figure 10. Editing the Dial-Up Connection Properties

9. Go to the 'Networking' tab. Ensure that 'Internet Protocol (TCP/IP)' is the only option selected under 'Components checked are used by this connection'.

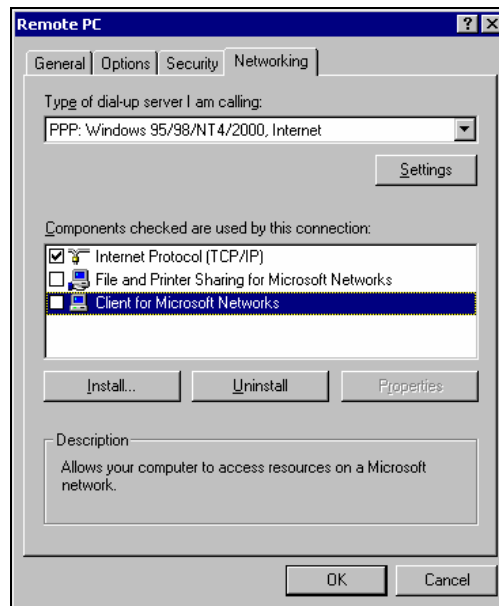

Figure 11. Configuring the Dial-Up Connection for TCP/IP

6.0 Call Setup

Once a connection has been manually made on the Black (secure) side of the connection, follow the instructions below to initiate the KlasHopper PPP connection:

1. Go to 'Start – Settings – Network and Dial-up Connections'.
2. Double-click on the connection that you have just created (*Remote PC*).
3. Click 'Dial' to initiate the call.

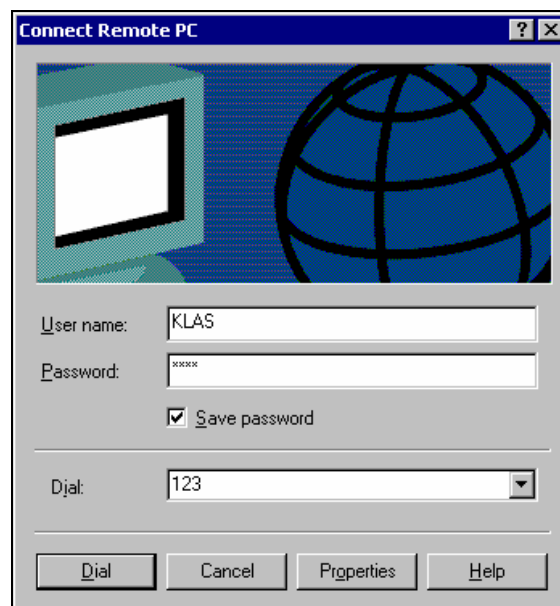

Figure 12. Initiating the KlasHopper PPP Connection

Dial with a KlasHopper 600 Connected to a KIV-7

MORE INFORMATION

For more information about the KlasHopper 600 PCMCIA and other Klas products, visit the following Klas website:

<www.klasonline.com>

Copyright © 2006 Klas Ltd. All rights reserved. All company and brand names are trademarks or registered trademarks of their respective owners.

DISCLAIMER OF WARRANTY: THE DOCUMENT IS PROVIDED AS IS, WITHOUT WARRANTY OF ANY KIND. TO THE MAXIMUM EXTENT PERMITTED BY APPLICABLE LAW, WITH RESPECT TO THE DOCUMENT AND / OR ANY ASSOCIATED ON-LINE INFORMATION, KLAS DISCLAIMS ALL WARRANTIES, EITHER EXPRESS OR IMPLIED, INCLUDING BUT NOT LIMITED TO IMPLIED WARRANTIES OF MERCHANTABILITY AND FITNESS FOR A PARTICULAR PURPOSE, AND NONINFRINGEMENT.